



TX-BGRWY10B140-001C

PRODUCT SPECIFICATION

Approved by:

Checked by:

Prepared by:

Part No.	TX-BGRWY10B140-001C	Spec No.	WKF-BB9034	Page	1 of 10
-----------------	---------------------	-----------------	------------	-------------	---------



Features:

- ↵ Excellent Transiting Heat from LED Chip Operating under 500mA
- ↵ High Luminous Output
- ↵ No UV

Typical purpose:

- ↵ Portable Flashlight
- ↵ Garden lighting
- ↵ General Lighting

Package Dimensions:

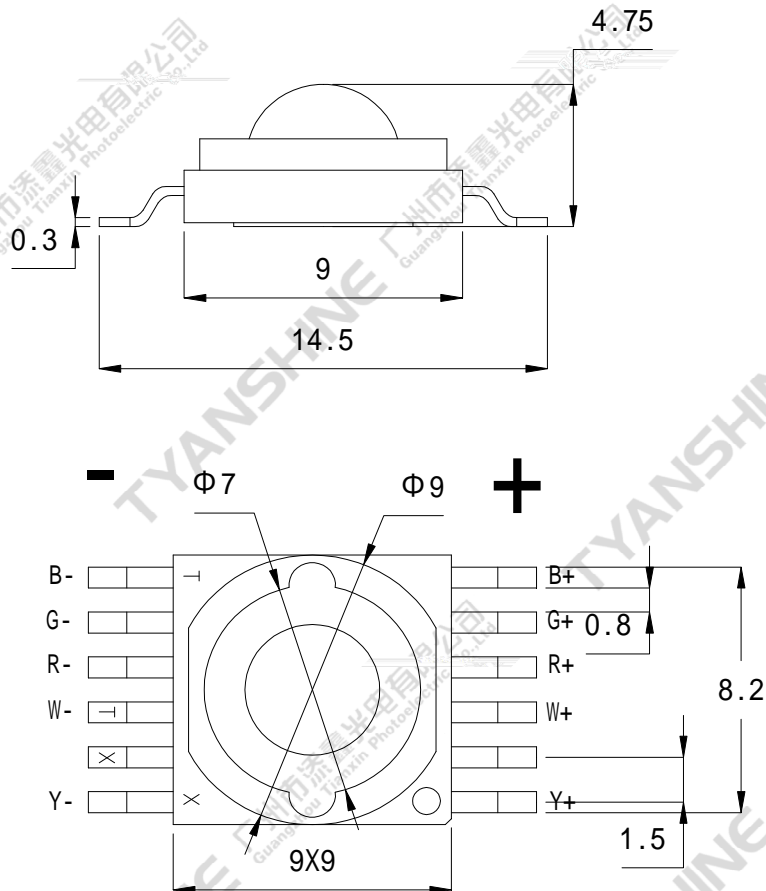

Part No.	TX-BGRWY10B140-001C	Spec No.	WKF-BB9034	Page	2 of 10
-----------------	---------------------	-----------------	------------	-------------	---------



Notes:

- 1.The white light for thermoelectric integrated chip of this product.
- 2.All dimensions are in millimeters (inches).
3. Tolerance is ± 0.25 mm (0.01") unless otherwise noted.

Part NO.	Chip Material					Lens Color	Source Color
	Blue	Green	Red	White	Yellow		
TX-BGRWY10B140-001C	Blue	Green	Red	White	Yellow	Water Clear	Blue & Green & Red & White & Yellow
890000 0 0/Cs1 1.00-2.890000	3.0(w)	2.0(w)	1.9(w)	1.9(w)	32.0(.)7.9(t)	8.0(50 0 Tm)	149 10 0/Cs1 1.00-5019149

Absolute Maximum Ratings at Ta=25 "

Notes:

1. Specifications are subject to change without notice.
2. Under the stipulated Characteristics parameters above, the life span of the LED is more than 50,000hours.
3. The data on this specification is for reference only and the actual data is in accordance with the acknowledgment.
4. Precautions for ESD:
 STATIC SHIELD Electricity and surge damages the LED. It is recommended to use a wrist band or anti-electrostatic glove when handling the LED. All devices, equipment and machinery must be properly grounded.

Part No.	TX-BGRWY10B140-001C	Spec No.	WKF-BB9034	Page	3 of 10
-----------------	---------------------	-----------------	------------	-------------	---------



Characteristics at If=500mA ,Vr=5V (Ta=25°C)

Parameter	Symbol	Emitting Color	Values			Units
			Min.	Typ.	Max.	
Luminous Flux	ν	B	25	40	—	lm
		G	125	150	—	
		R	80	105	—	
		W	145	180	—	
		Y	70	105	—	
Viewing Angle at 50 μ V	2 $\frac{1}{2}$	B	—	140	—	Deg
		G	—	140	—	
		R	—	140	—	
		W	—	140	—	
		Y	—	140	—	
Peak Emission Wavelength	ρ	B	455	458	462	nm
		G	510	515	520	
		R	628	632	635	
		Y	590	594	598	
Dominant Wavelength	d	B	458	461	465	nm
		G	522	526	529	
		R	618	622	625	
		Y	588	592	595	
Correlated Colour Temperature	CCT	W	5500	7000	8500	K
Spectral Line Half-Width	Δ	B	15	20	25	nm
		G	25	30	35	
		R	15	20	25	
		W	15	20	25	
		Y	10	15	20	
Forward Voltage	V_f	B	3.0	3.3	3.6	V
		G	3.0	3.3	3.6	
		R	2.0	2.3	2.6	
		W	2.9	3.2	3.5	
		Y	2.0	2.3	2.6	
Reverse Current	I_R	—	—	10	μ A	
Thermal Resistance Junction to Case	R_{J-C}	—	4.5	—	K/W	
Temperature Coefficient of Forward Voltage	V_f/T	—	—	-2	mV/°C	



Notes:

- 1. Luminous intensity is

Part No.	TX-BGRWY10B140-001C	Spec No.	WKF-BB9034	Page	5 of 10
-----------------	---------------------	-----------------	------------	-------------	---------



Typical Electrical / Optical Characteristics Curves

(25 ° Ambient Temperature Unless Otherwise Noted)

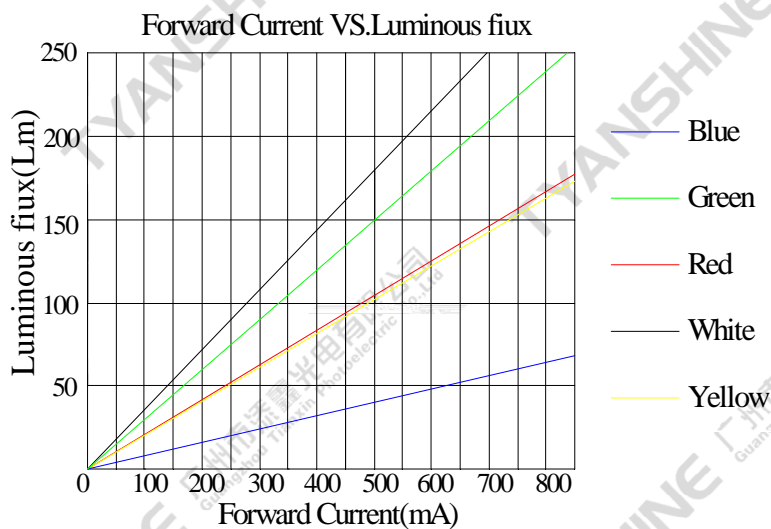
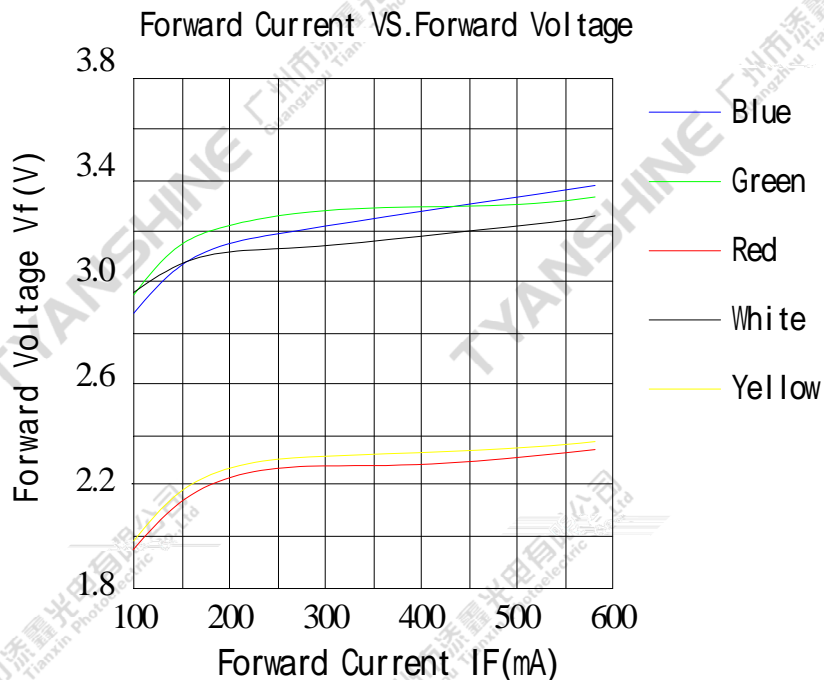

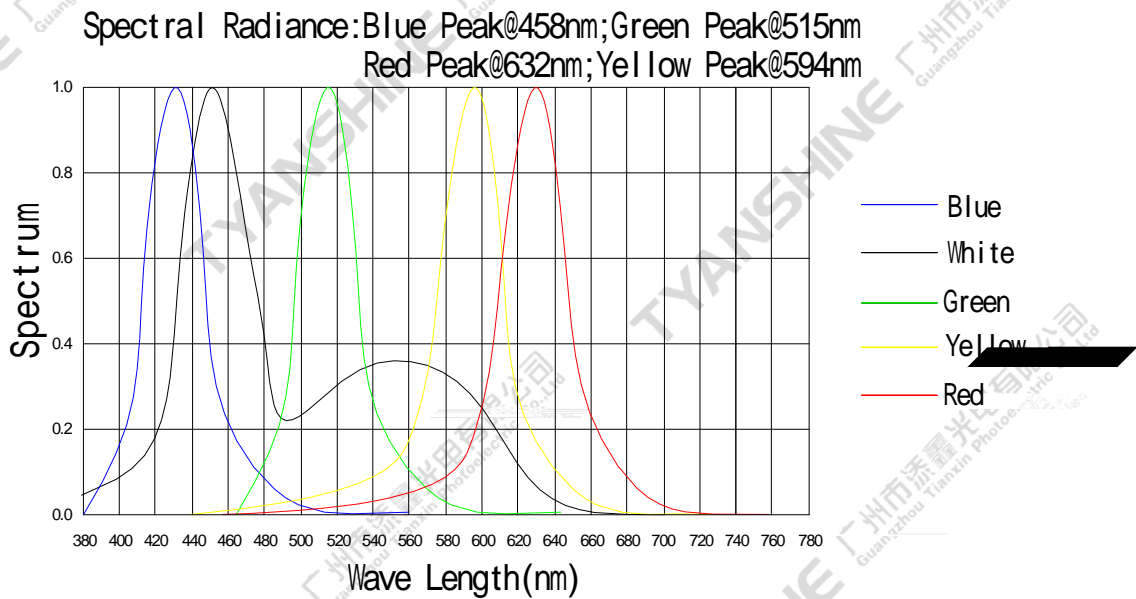
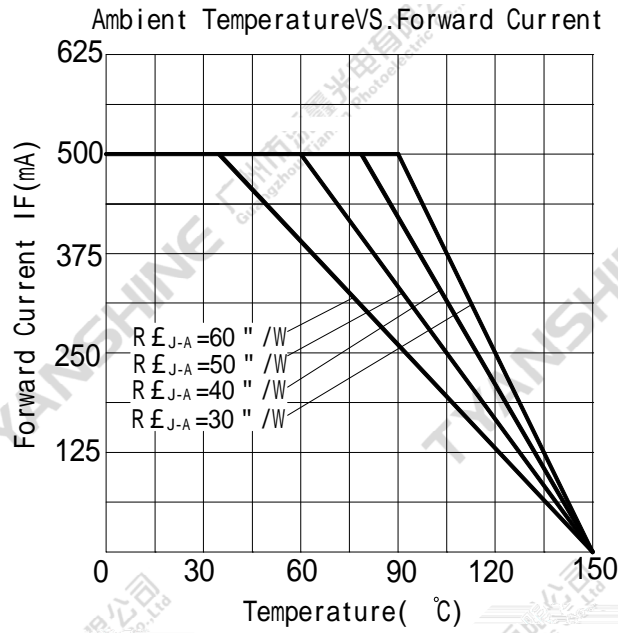

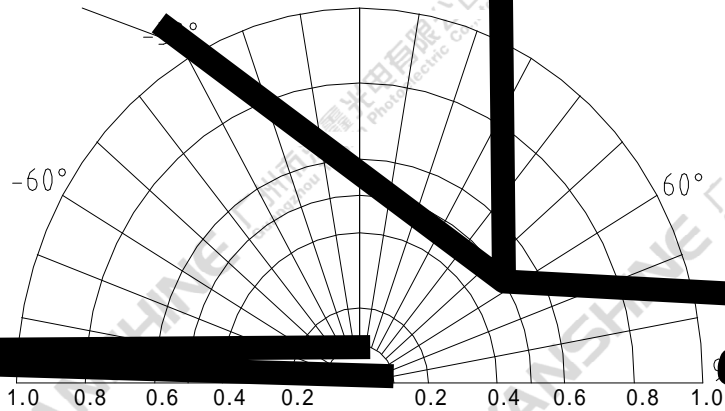

TYANSHINE 广州市添鑫光电有限公司 Guangzhou Tianxin Photoelectric Co., Ltd.

Part No.	TX-BGRWY10B140-001C	Spec No.	WKF-BB9034	Page	8 of 10
-----------------	---------------------	-----------------	------------	-------------	---------

PRECAUTION IN USE

Storage

Recommended storage environment
 Temperature: 5 " ~ 30 " (41oF ~ 86oF)
 Humidity: 60% RH Max.

Soldering

Use the conditions shown to the under figure.

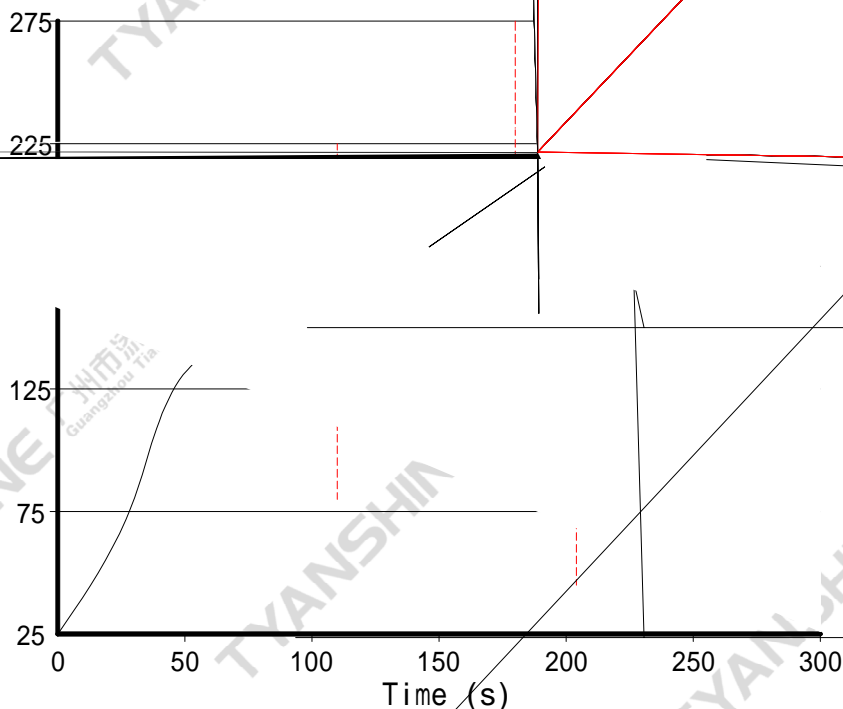



Dimensions for Cannulation and Packaging

Quantity: 40PCS

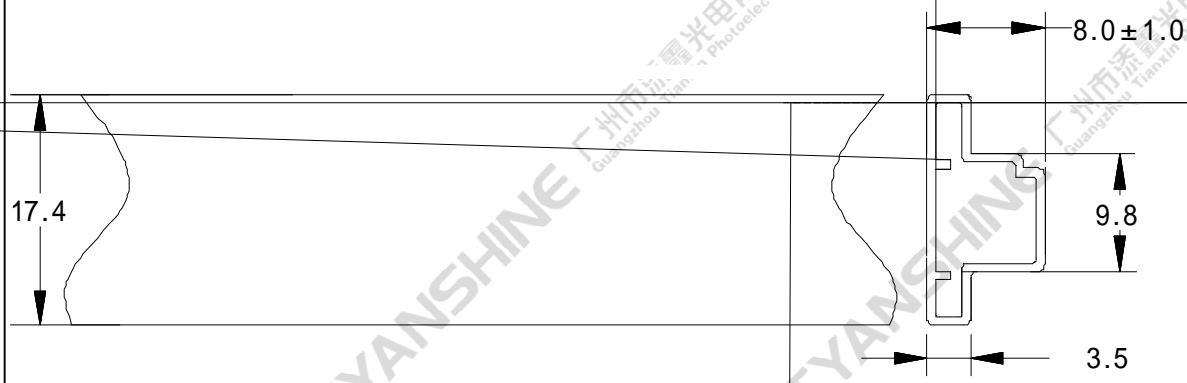

Part No.	TX-BGRWY10B140-001C	Spec No.	WKF-BB9034	Page	10 of 10
-----------------	---------------------	-----------------	------------	-------------	----------