

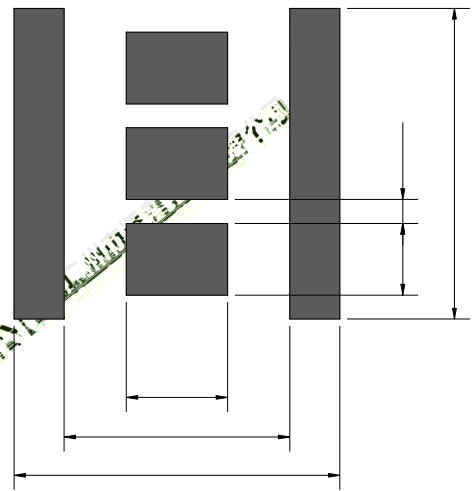

--	--	--	--	--	--

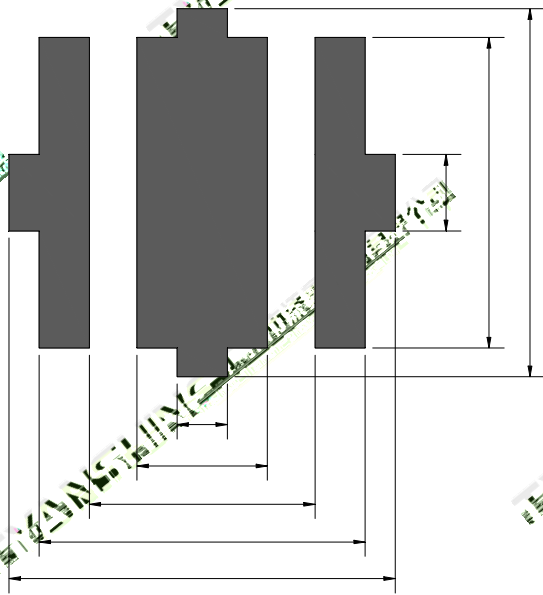

--	--	--	--	--	--

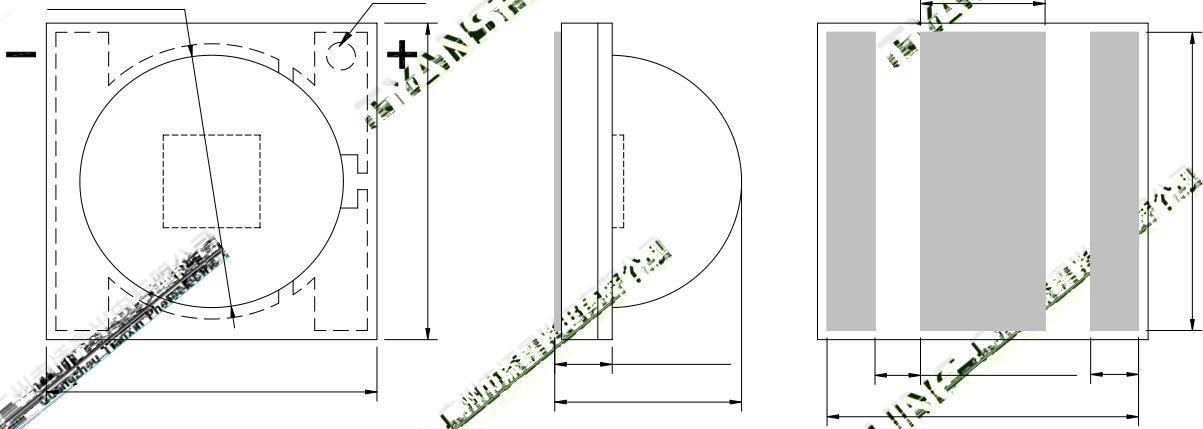

--	--	--	--	--	--

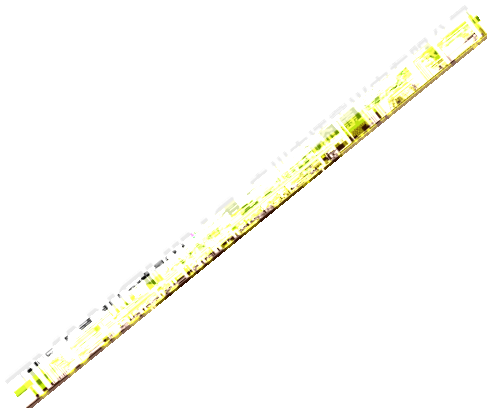
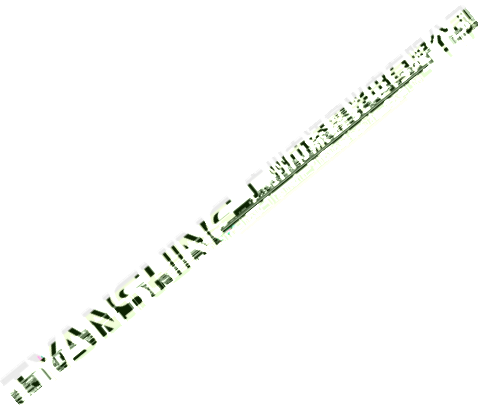
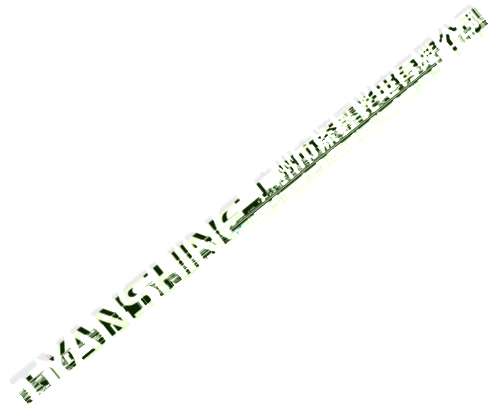
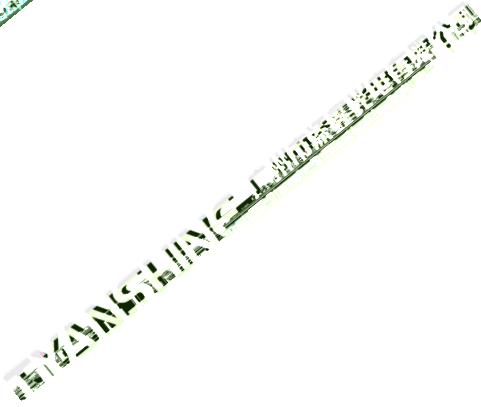
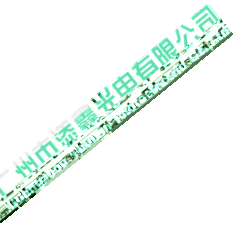
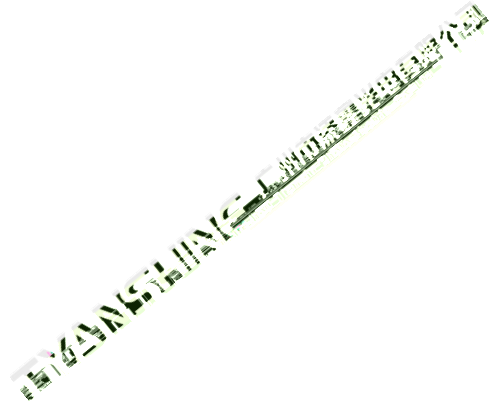
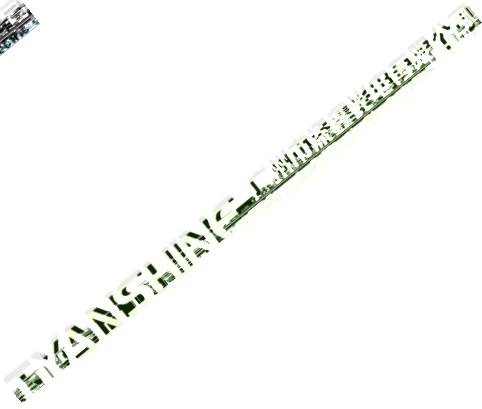
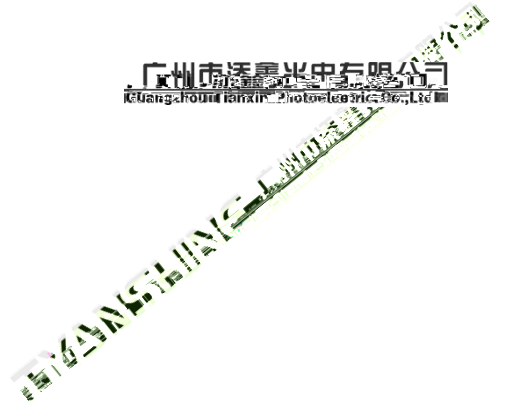
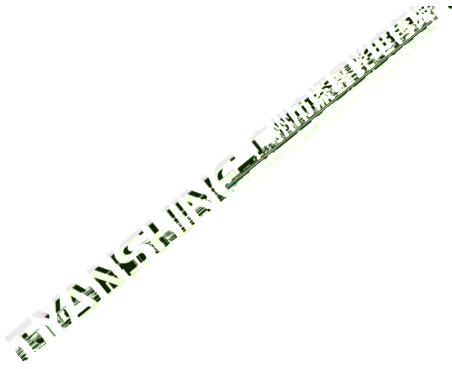
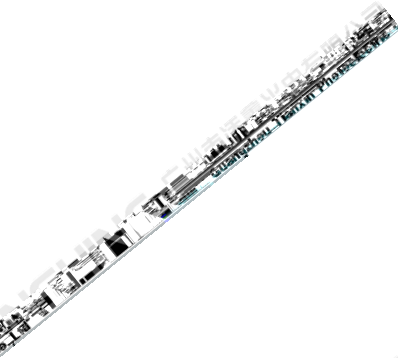

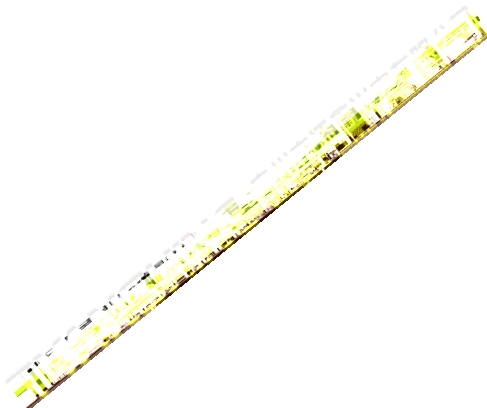
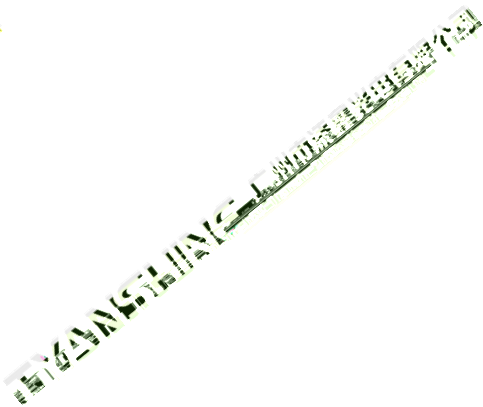
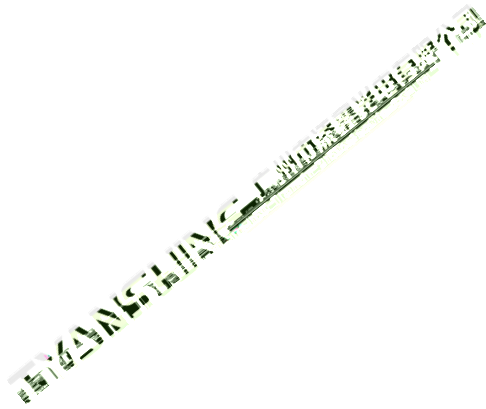
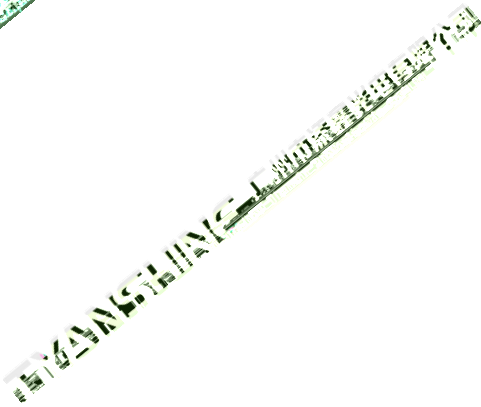
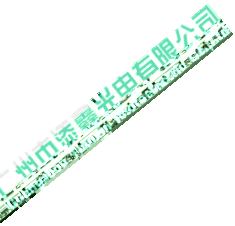
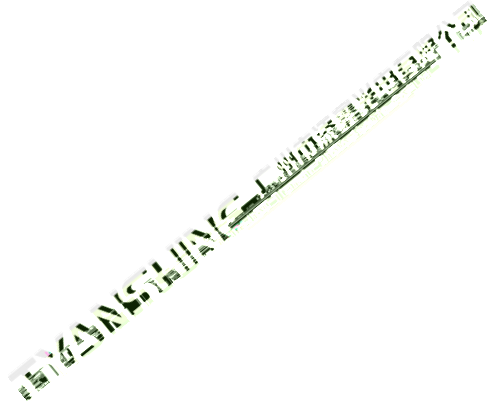
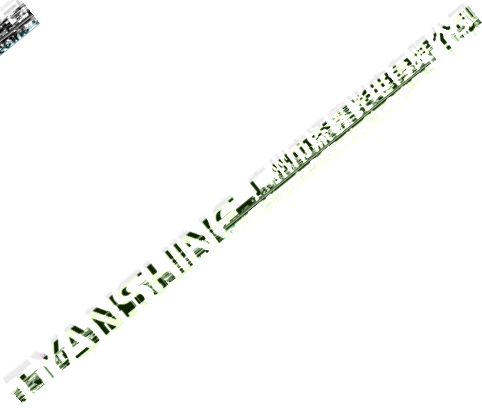
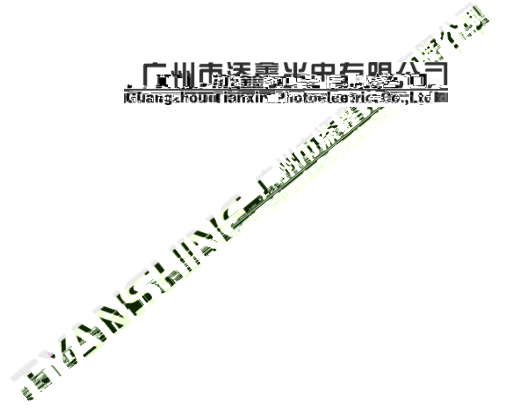
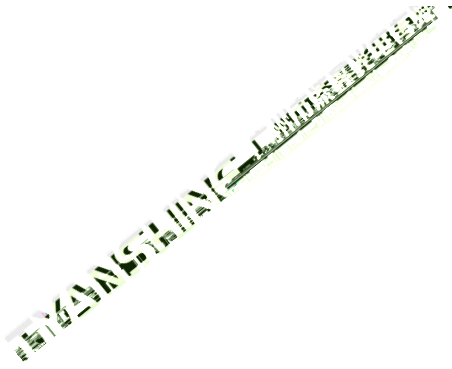
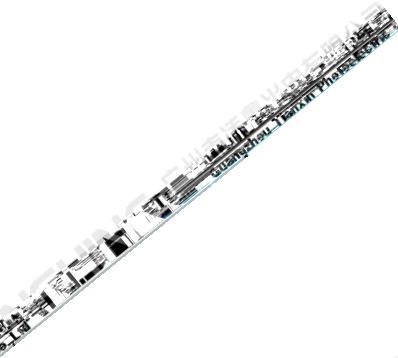

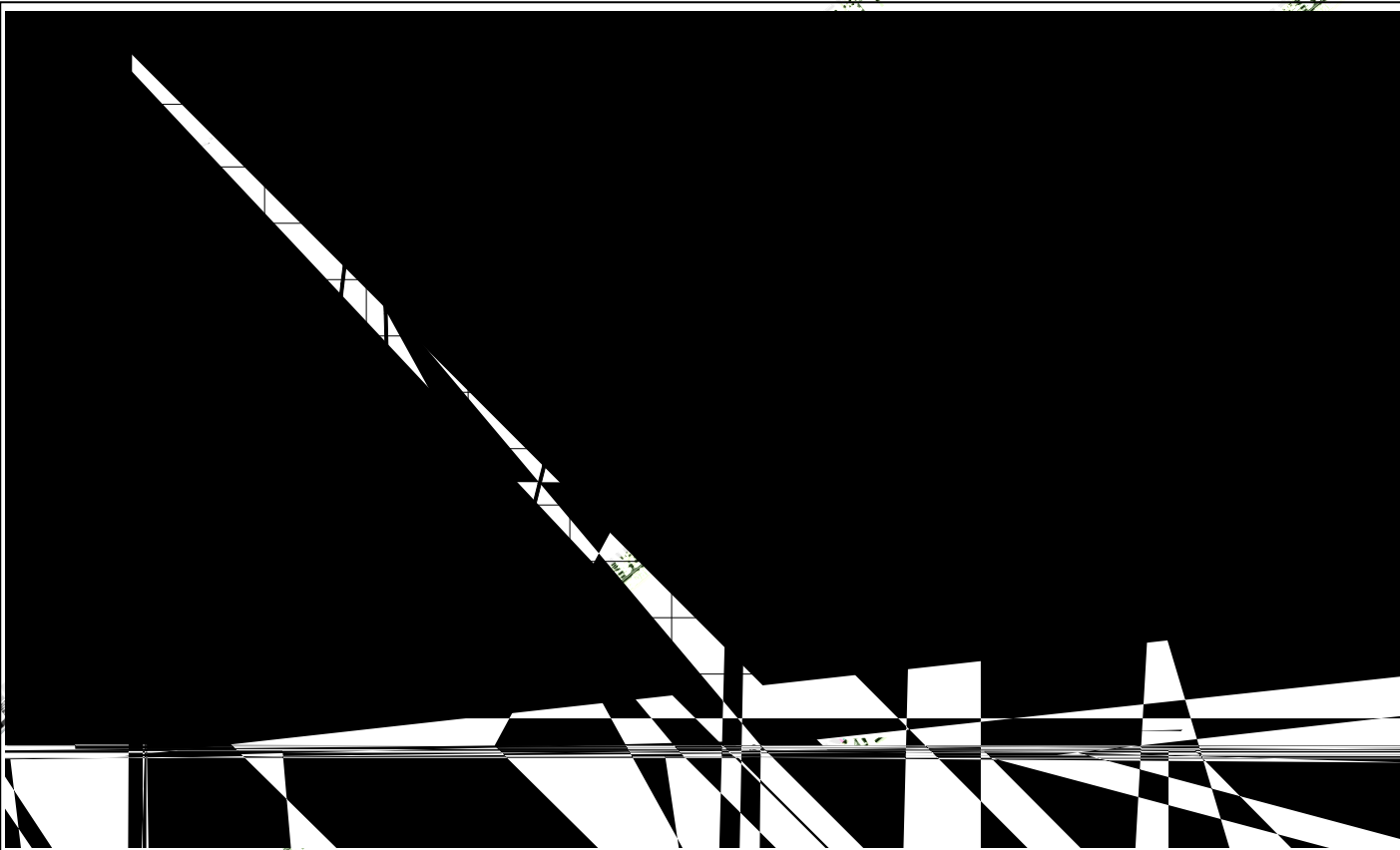

--	--	--	--	--	--

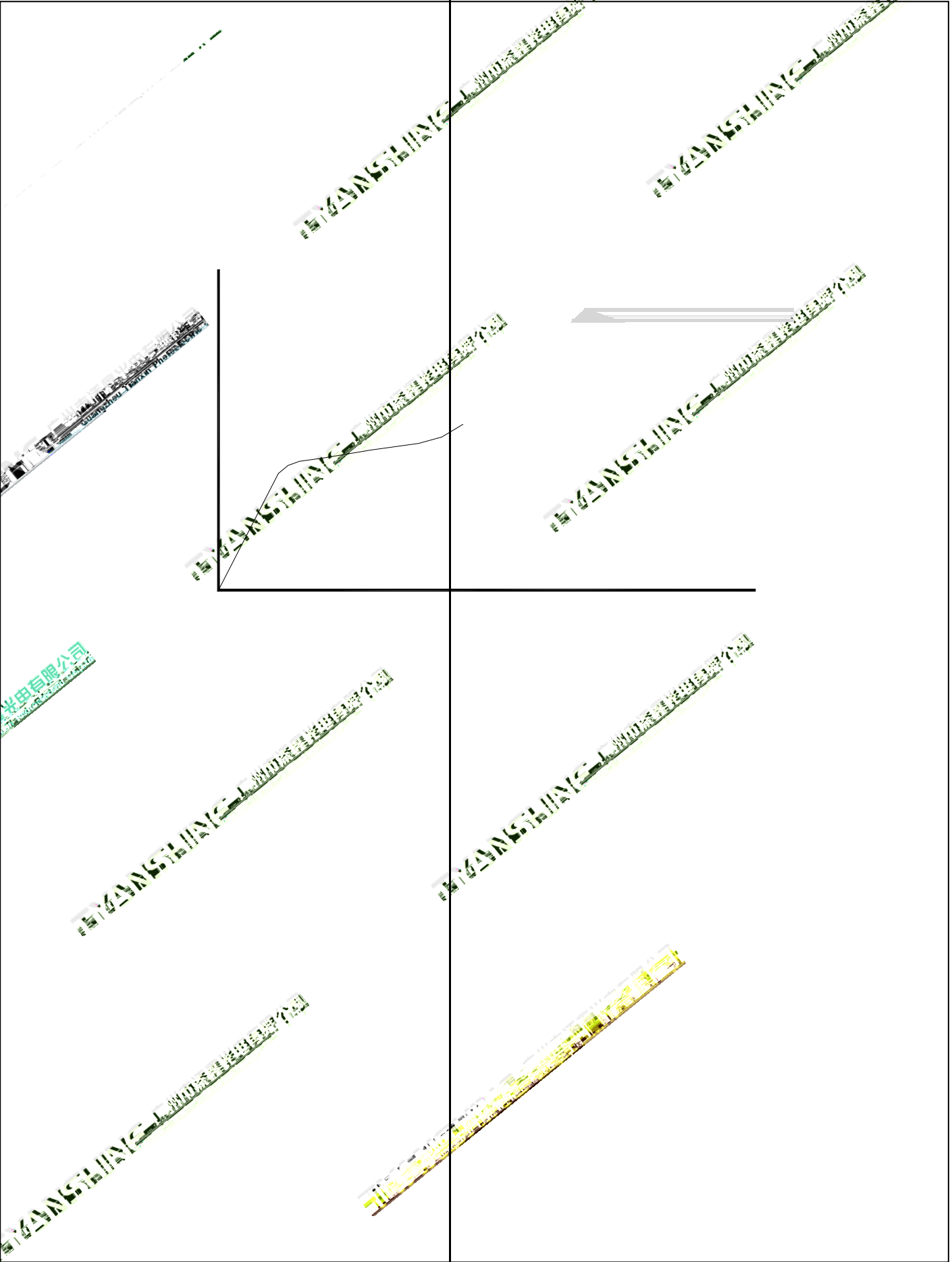

--	--	--	--	--	--

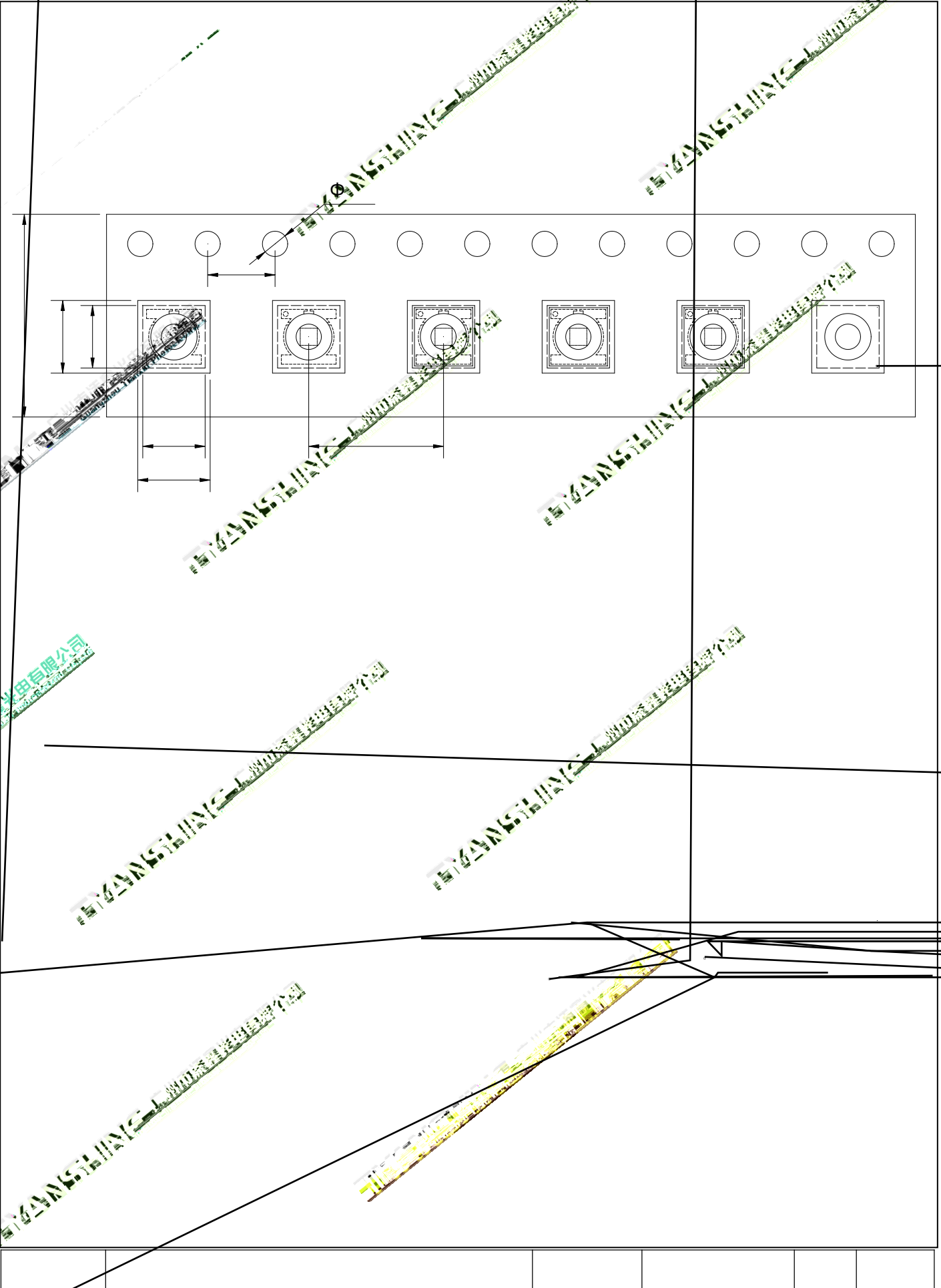

广州市潘嘉光电有限公司
Guangzhou Panjia Photoelectronics Co., Ltd.

广州市潘嘉光电有限公司
Guangzhou Panjia Photoelectronics Co., Ltd.

广州市潘嘉光电有限公司
Guangzhou Panjia Photoelectronics Co., Ltd.

广州市潘嘉光电有限公司
Guangzhou Panjia Photoelectronics Co., Ltd.

广州市潘嘉光电有限公司
Guangzhou Panjia Photoelectronics Co., Ltd.



--	--	--	--	--	--