



CANEC24021252912

2024 10 09

1 10

15

LED

SGS

GZP24-031628

2024 09 24

2024 09 24 ~ 2024 09 29

RoHS	2011/65/EU	II	(EU) 2015/863-
(DEHP)	(PBB)	(PBDE)	(2-)
(DIBP)	(BBP)	(DBP)	
RoHS	2011/65/EU	II	(EU) 2015/863-

钟臻

Jany Zhong

scan to see the report

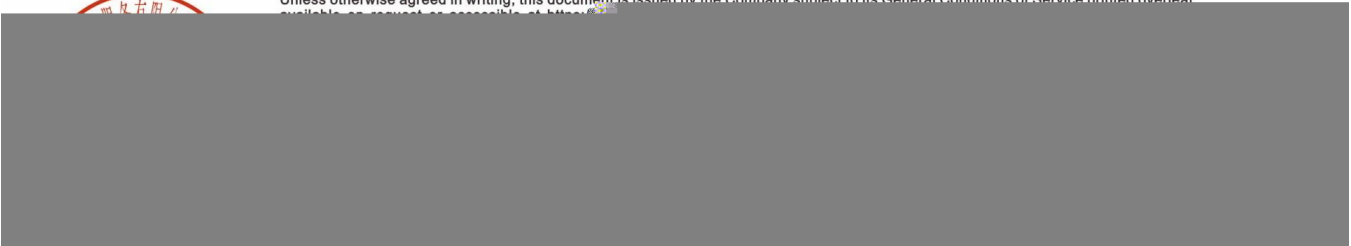

		SGS ID	
SN1	A20	CAN24-0212529-0001.C020	
SN2	A21	CAN24-0212529-0001.C021	
SN3	A22	CAN24-0212529-0001.C022	
SN4	A23	CAN24-0212529-0001.C023	
SN5	A24	CAN24-0212529-0001.C024	

(1) 1 mg/kg = 1 ppm = 0.0001%

(2) MDL=

(3) ND = (< MDL)

(4) "-" =

RoHS	2011/65/EU	II	(EU) 2015/863-	(PBB)
(PBDE)	(2-)	(DEHP)	(BBP)
(DBP)	(DIBP)			

IEC 62321-4:2013+AMD1:2017 IEC 62321-5:2013 IEC 62321-7-2:2017 IEC 62321-12:2023 ICP-OES/AAS UV-Vis GC-MS

			MDL	A20	A21
(Pb)	1000	mg/kg	2	ND	5
(Hg)	1000	mg/kg	2	ND	ND
(Cd)	100	mg/kg	2	ND	ND
(Cr(VI))	1000	mg/kg	8	ND	ND
(PBB)	1000	mg/kg	-	ND	ND
(MonoBB)	-	mg/kg	25	ND	ND
(DiBB)	-	mg/kg	25	ND	ND
(TriBB)	-	mg/kg	25	ND	ND
(TetraBB)	-	mg/kg	25	ND	ND
(PentaBB)	-	mg/kg	25	ND	ND
(HexaBB)	-	mg/kg	25	ND	ND
(HeptaBB)	-	mg/kg	25	ND	ND
(OctaBB)	-	mg/kg	25	ND	ND
(NonaBB)	-	mg/kg	25	ND	ND
(DecaBB)	-	mg/kg	25	ND	ND
(PBDE)	1000	mg/kg	-	ND	ND
(MonoBDE)	-	mg/kg	25	ND	ND

			MDL	A20	A21
(DiBDE)	-	mg/kg	25	ND	ND
(TriBDE)	-	mg/kg	25	ND	ND
(TetraBDE)	-	mg/kg	25	ND	ND
(PentaBDE)	-	mg/kg	25	ND	ND
(HexaBDE)	-	mg/kg	25	ND	ND
(HeptaBDE)	-	mg/kg	25	ND	ND
(OctaBDE)	-	mg/kg	25	ND	ND
(NonaBDE)	-	mg/kg	25	ND	ND
(DecaBDE)	-	mg/kg	25	ND	ND
(2-) (DEHP)	1000	mg/kg	50	ND	ND
(BBP)	1000	mg/kg	50	ND	ND
(DBP)	1000	mg/kg	50	ND	ND
(DIBP)	1000	mg/kg	50	ND	ND

- (1) RoHS (EU) 2015/863
(2) IEC 62321 EN 62321
(3) 2021 7 22 DEHP BBP DBP DIBP

IEC 62321-4:2013+AMD1:2017 IEC 62321-5:2013 IEC 62321-7-2:2017 IEC 62321-12:2023 ICP-OES/AAS UV-Vis GC-MS

			MDL	A24
(Pb)	1000	mg/kg	2	ND
(Hg)	1000	mg/kg	2	ND
(Cd)	100	mg/kg	2	ND
(Cr(VI))	1000	mg/kg	8	ND
(PBB)	1000	mg/kg	-	ND
(MonoBB)	-	mg/kg	25	ND
(DiBB)	-	mg/kg	25	ND
(TriBB)	-	mg/kg	25	ND
(TetraBB)	-	mg/kg	25	ND
(PentaBB)	-	mg/kg	25	ND
(HexaBB)	-	mg/kg	25	ND
(HeptaBB)	-	mg/kg	25	ND
(OctaBB)	-	mg/kg	25	ND
(NonaBB)	-	mg/kg	25	ND
(DecaBB)	-	mg/kg	25	ND
(PBDE)	1000	mg/kg	-	ND
(MonoBDE)	-	mg/kg	25	ND
(DiBDE)	-	mg/kg	25	ND
(TriBDE)	-	mg/kg	25	ND

CANEC24021252912

2024 10 09

4 10

			MDL	A24
(TetraBDE)	-	mg/kg	25	ND
(PentaBDE)	-	mg/kg	25	ND
(HexaBDE)	-	mg/kg	25	ND
(HeptaBDE)	-	mg/kg	25	ND
(OctaBDE)	-	mg/kg	25	ND
(NonaBDE)	-	mg/kg	25	ND
(DecaBDE)	-	mg/kg	25	ND
(2-) (DEHP)	1000	mg/kg	50	ND
(BBP)	1000	mg/kg	50	ND
(DBP)	1000	mg/kg	50	ND
(DIBP)	1000	mg/kg	50	ND

- (1) RoHS (EU) 2015/863
 (2) IEC 62321 EN 62321
 (3) 2021 7 22 DEHP BBP DBP DIBP

RoHS 2011/65/EU II (EU) 2015/863-

IEC 62321-4:2013+AMD1:2017 IEC 62321-5:2013 IEC 62321-7-1:2015 ICP-
 OES/AAS UV-Vis

			MDL	A22	A23
(Pb)	1000	mg/kg	2	6	36
(Hg)	1000	mg/kg	2	ND	ND
(Cd)	100	mg/kg	2	ND	ND
(Cr(VI))	-	µg/cm ²	0.10	ND	ND

A24

ILAC-G8:09/2019

w=0

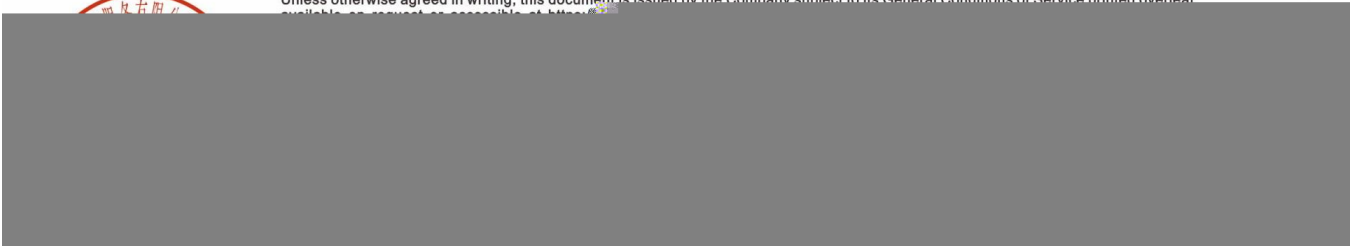
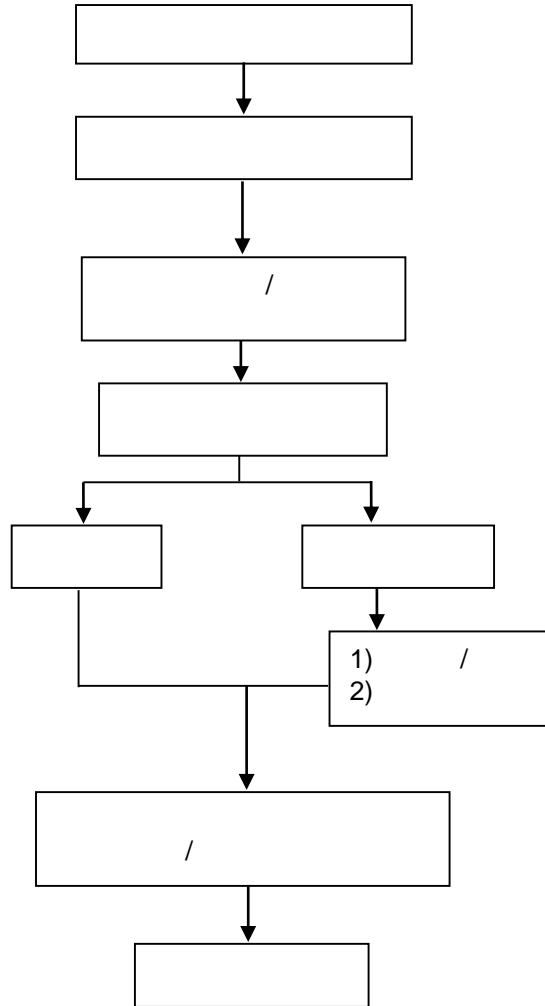

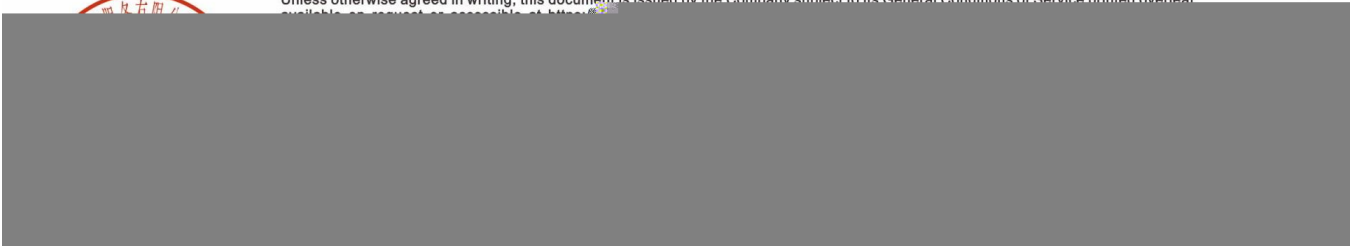
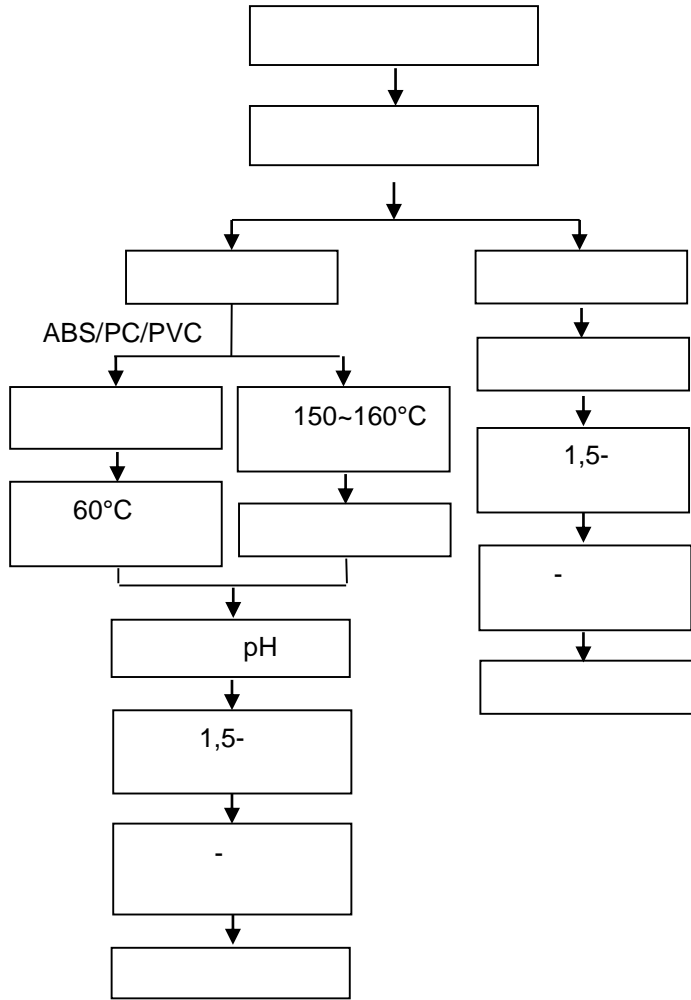



PBB/PBDE/Phthalates

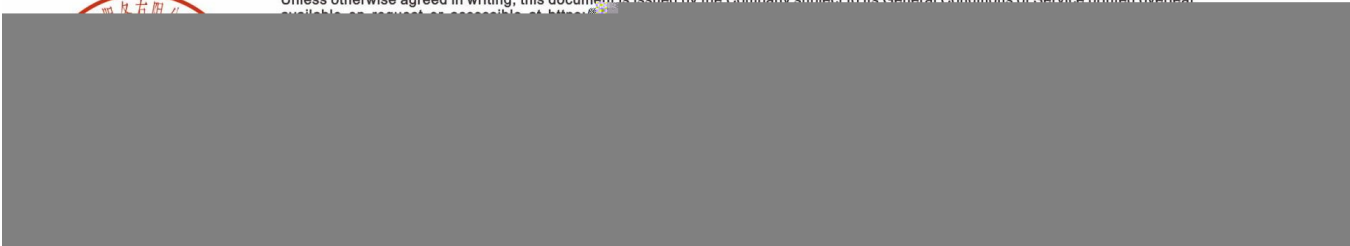

CANEC24021252912

2024 10 09

8 10

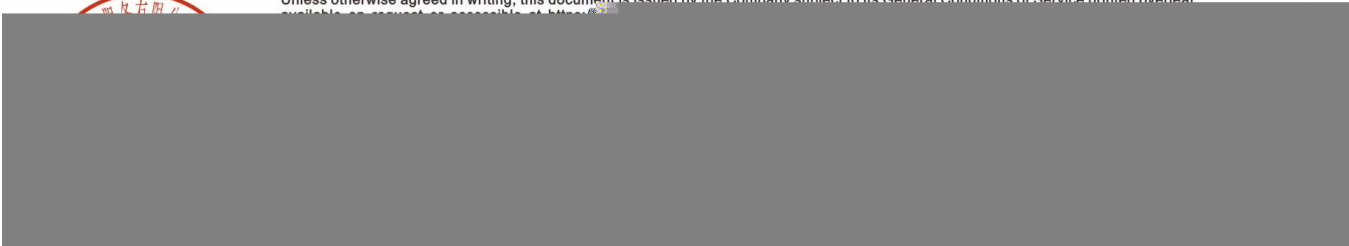
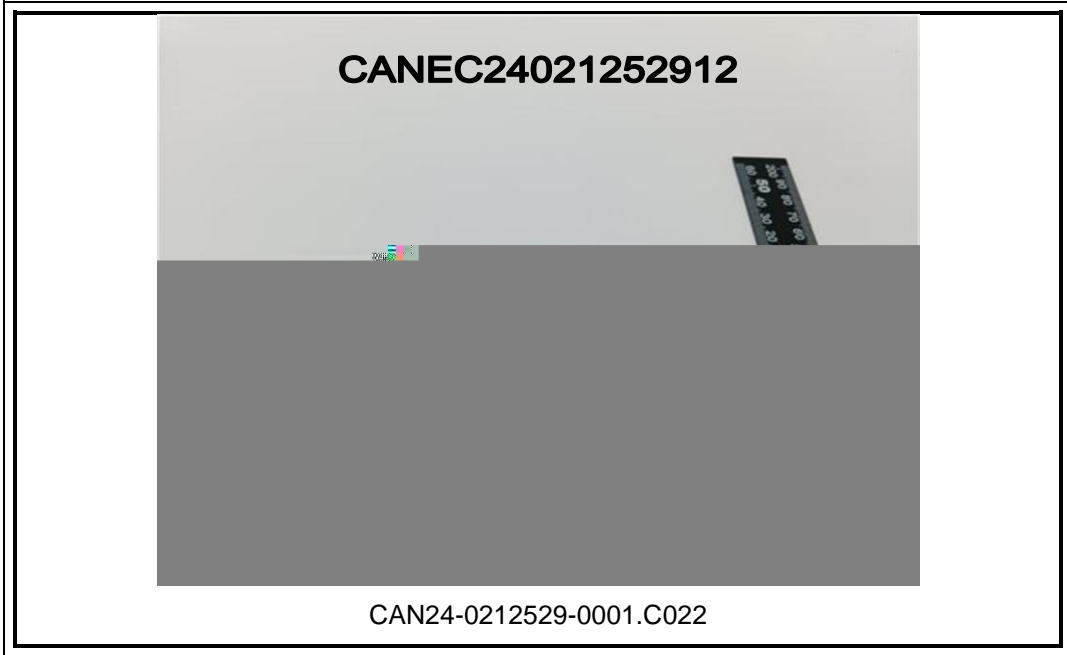



CANEC24021252912

2024 10 09

10

10



Unless otherwise agreed in writing, this document is issued by the Company subject to its General Conditions of Service printed overleaf available on request or accessible at <https://www.foxconn.com>

